



MEN -002-B



GARAGE DOOR OPENER INSTALLATION MANUAL



- Please read the manual and the enclosed safety materials carefully!
- Fasten the manual near the garage door after installation.
- Periodic checks of the opener are required to ensure safe operation.
- The model number label is located on the left side panel of your opener.

TABLE OF CONTENTS

INTRODUCTION	3
Tools needed	5
Assemble the Rail	6
Garage door opener assembly	10
Hardware.....	10
Fasten the Rail to the garage door opener.....	12
Determine the Header Bracket Location.....	13
Install the Header Bracket.....	15
Connect the Rail to the Header Bracket.....	17
Position the garage door opener.....	18
Hang the garage door opener.....	19
Attach the Emergency Release Rope and Handle.....	20
Install the door bracket.....	21
Connect the door arm to the trolley.....	23
Install the Wall Control	25
Attach the Warning Labels	28
Install The Photo Eye Safety System	29
Power and adjustments	33
Programming and adjustment	34
Programming buttons.....	34
Preparation.....	34
Connect Power.....	34
Program the travel.....	35
Remote Control.....	36
To Erase the Memory.....	37
The adjustment of reverse force.....	38
Circuit board.....	40
Use photoelectric switches.....	41
Turn off light automatically	42
Power failure clutch lock	42
Backup battery	42
Door within a Door	43
Maintenance and repair	43
Technical parameter	43
Trouble shooting	44

INTRODUCTION

Safety Symbol and Signal Word Review

This garage door opener has been designed and tested to offer safe service provided it is installed, operated, maintained and tested in strict accordance with the instructions and warnings contained in this manual. When you see these Safety Symbols and Signal Words on the following pages, they will alert you to the possibility of **serious injury or death** if you do not comply with the warnings that accompany them.

The hazard may come from something or from electric shock. Read the warnings carefully.



Mechanical



Electrical

When you see this Signal Word on the following pages, it will alert you to the possibility of damage to your garage door and/or the garage door opener if you do not comply with the cautionary statements that accompany it. Read them carefully.



Check your garage door

1. Disable locks and remove any ropes connected to the garage door.
2. Lift the door halfway up. Release the door. If balanced, it should stay in place, supported entirely by its springs.
3. Raise and lower the door to check for binding or sticking. If your door binds, or is out of balance, call a trained door systems technician.
4. Check the seal on the bottom of the door. Any gap between the floor and the bottom of the door must not exceed 1/4 inch (6 mm). Otherwise, the safety reversal system may not work properly.

5. The opener should be installed above the center of the door. If there is a torsion spring or center bearing plate in the way of the header bracket, it may be installed within 4 feet (1.2 m) to the left or right of the door center. See Installing the Header Bracket section.



WARNING

To prevent possible **SERIOUS INJURY** or **DEATH**:

- **ALWAYS** call a trained door systems technician if garage door binds, sticks, or is out of balance. An unbalanced garage door may not reverse when required.
- **NEVER** try to loosen, move or adjust garage door, door springs, cables, pulleys, brackets or their hardware, **ALL** of which are under **EXTREME** tension.
- Disable **ALL** locks and remove **ALL** ropes connected to garage door **BEFORE** installing and operating garage door opener to avoid entanglement.



WARNING

To reduce the risk of injury to persons
Use this operator only with Sectional

CAUTION

To prevent damage to garage door and opener:

- **ALWAYS** disable locks **BEFORE** installing and operating the opener.
- **ONLY** operate garage door opener at 230V, 50 Hz to avoid malfunction and damage.

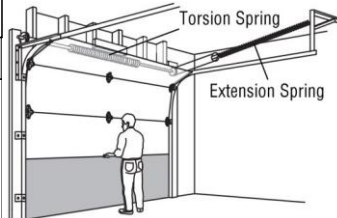

Tools needed

During assembly, installation and adjustment of the opener, instructions will call for hand tools as illustrated below.

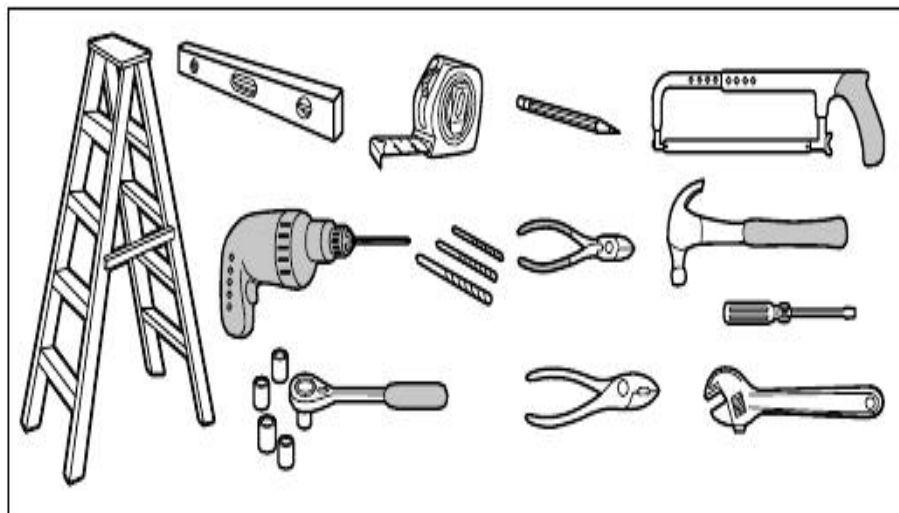





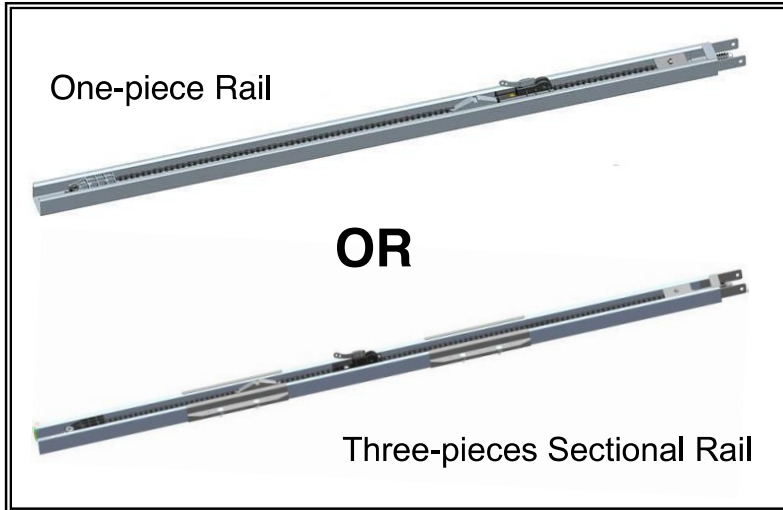

1. Assemble the Rail

To avoid installation difficulties, do not run the garage door opener until instructed to do so.



NOTE: If you choose the **Three-pieces Sectional Rail**, you may need the following installation instructions.

Rail Accessories

					
A1	A2	A3	A4	A5	A6
Rail connector A (2)	Rail connector B (2)	Square neck bolt M8 (8)	Flange nut M8 (8)	Screw M5×20 (2)	lock washer M5 (2)

Assemble the Rail

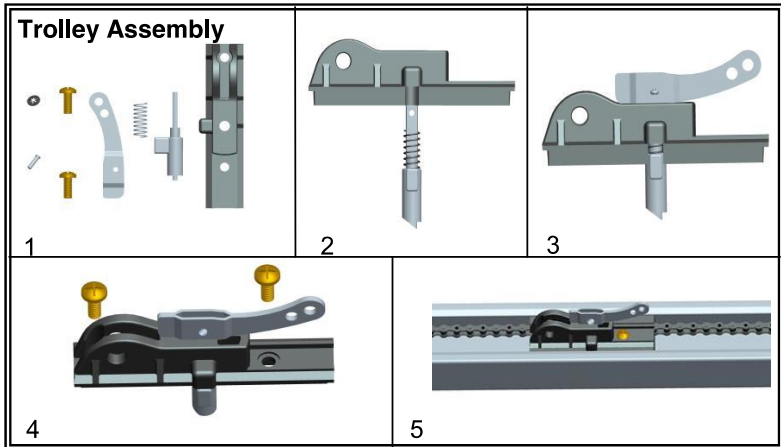
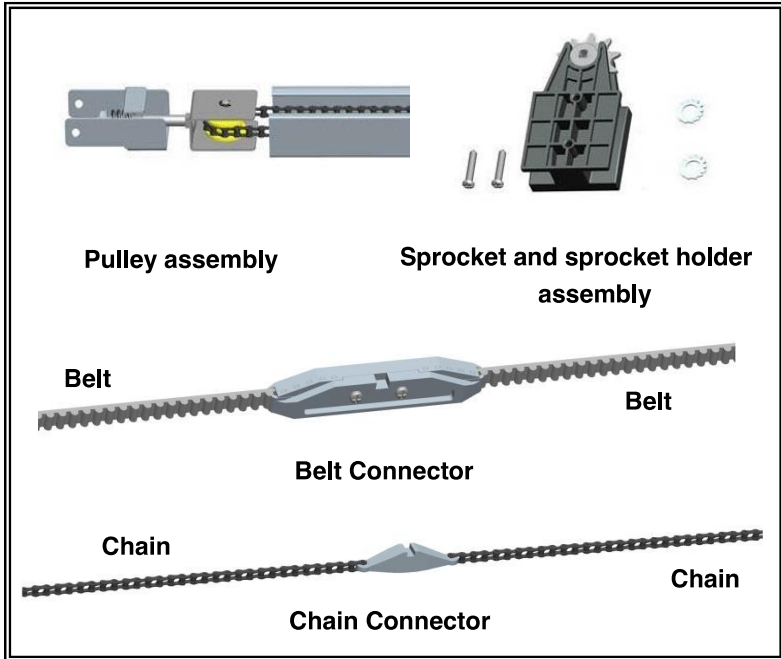

Assemble the Rail

1.1、 Remove the three rail sections and place them on

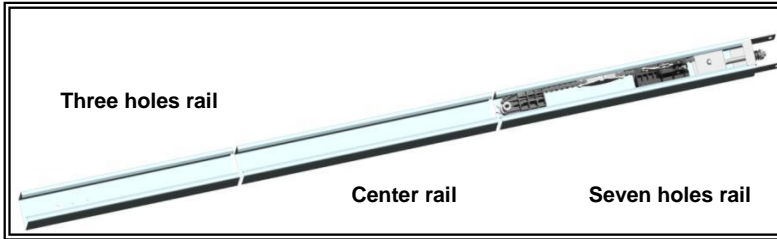

1.2、 Rail connectors installation.

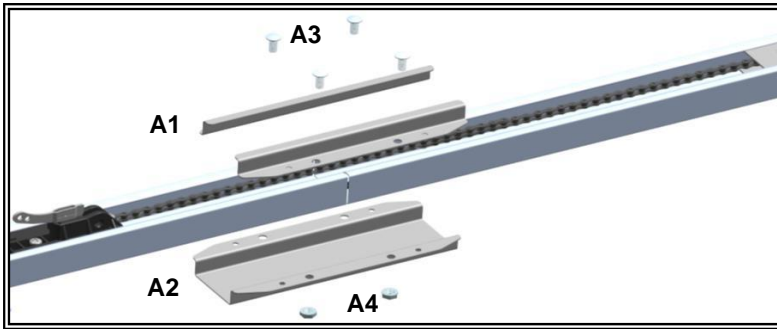

1.3、 Spread carefully the chain/belt straight inside the rail. Check to be sure the chain is not twisted. Note: Make sure the chain engage the 10-tooth sprocket as shown.



Assemble the Rail

1.4 Screw and lock washer installation.

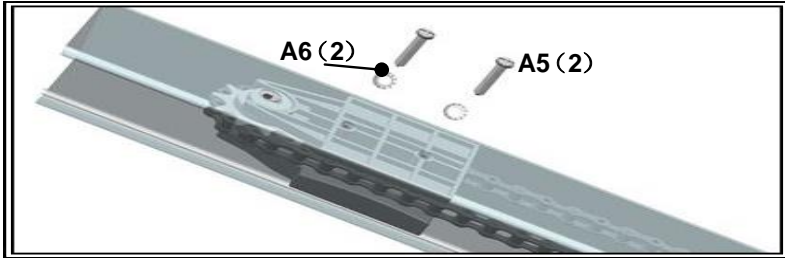

1.5. Tighten the Chain

1.5.1 To increase the tension and tighten the chain, turn the tension nut clockwise or adjustable wrench until the nut is spaced properly from the rail end -plate.

1.5.2 Once the nut is spaced correctly, any additional tightening will over tighten the chain and may cause damage to the system.

1.5.3 To loose the tension, turn nut counterclockwise.

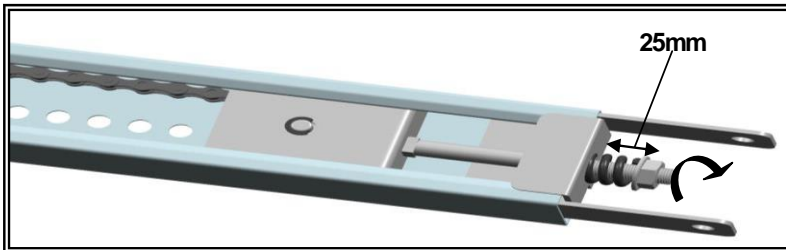



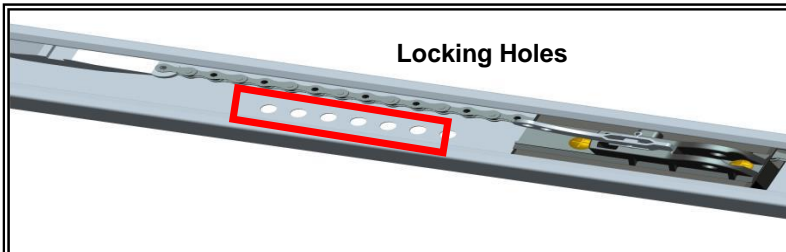











Note: the trolley should be away from locking holes.







Garage door opener assembly

Hardware

B1	B2	B3
Hex Bolt M8×20(6)	Flange nut M8 (4 or 2)	Lag Screw M8×50 (6)
		
B4	B5	B6
Shouldered shaft, short $\Phi 8 \times 30$ (2)	Cotter Pin $\Phi 2 \times 25$ (3)	Shouldered shaft, long $\Phi 8 \times 80$ (1)
		
B7	B8	B9
Hex Nut M8(6)	Self-drilling Screw M6×20 (4)	Expansion Pipe $\Phi 10 \times 50$
		
C1	C2	C3
Self-threading Screw M6×16 (4)	Hex Bolt M8×70 (2) May not provide	“U” rail clip
		
C4	C5	C6
Door bracket	Header bracket	Hanging bracket
		

Garage door opener assembly

C7	C8	C9
Straight door arm	Curved door arm	Middle support clip May not provide
		
D1		
"U" rail clip-2		
		

Garage door opener assembly

1、 Fasten the Rail to the garage door opener

- 1.1 Place the opener on cardboard or protective surface on floor so opener does not get scratched. Chassis side of opener is facing up.
- 1.2 Position rail onto opener chassis by lining up rail sprocket, Make sure shaft insert into rail sprocket. Press rail down firmly onto shaft and opener chassis. **DO NOT HAMMER.**
- 1.3 Position 2 “U” rail clips over rail and onto chassis. Insert self-threading screw (4) (H12) through rail clips holes and into chassis holes. and tighten self-threading screws firmly to hold rail to the garage door opener head.

Note: To avoid **SERIOUS** damage to garage door opener, use **ONLY** those bolts/fasteners mounted in the top of the opener.

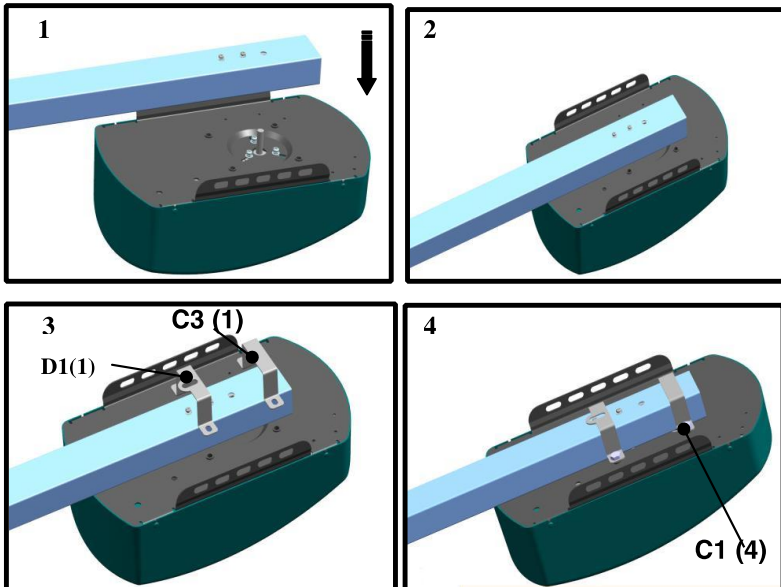

Garage door opener assembly

2、 Determine the Header Bracket Location



WARNING

To prevent possible **SERIOUS INJURY** or **DEATH**:

Header bracket **MUST** be **RIGIDLY** fastened to structural support on header wall or ceiling, otherwise garage door might not reverse when required. **DO NOT** install header bracket over drywall.

- Concrete anchors **MUST** be used if mounting header bracket or 2x4 into masonry.
- **NEVER** try to loosen, move or adjust garage door, springs, cables, pulleys, brackets, or their hardware, **ALL** of which are under **EXTREME** tension.
- **ALWAYS** call a trained door systems technician if garage door binds, sticks, or is out of balance. An unbalanced garage door might not reverse when required.

Installation procedures vary according to garage door types. Follow the instructions which apply to your door.

2.1 Close the door and mark the inside vertical centerline of the garage door.

2.2 Extend the line onto the header wall above the door.

You can fasten the header bracket within 4 feet (1.22 m) of the left or right of the door center only if a torsion spring or center bearing plate is in the way; or you can attach it to the ceiling when clearance is minimal. (It may be mounted on the wall upside down if necessary, to gain approximately 1/2" (1 cm). If you need to install the header bracket on a 2x4 (on wall or ceiling), use lag screws (not provided) to securely fasten the 2x4 to structural supports.

2.3 Open your door to the highest point of travel as shown. Draw an intersecting horizontal line on the header wall above the high point: 2" (5 cm) above the high point for sectional door with track. **NOTE:** If the total number of inches exceeds the height available in your garage, use the maximum height possible.

Garage door opener assembly

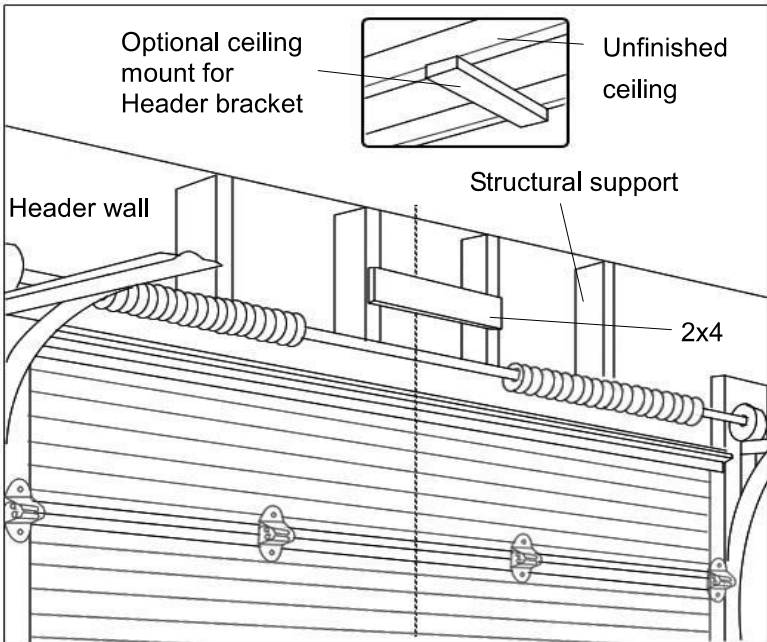
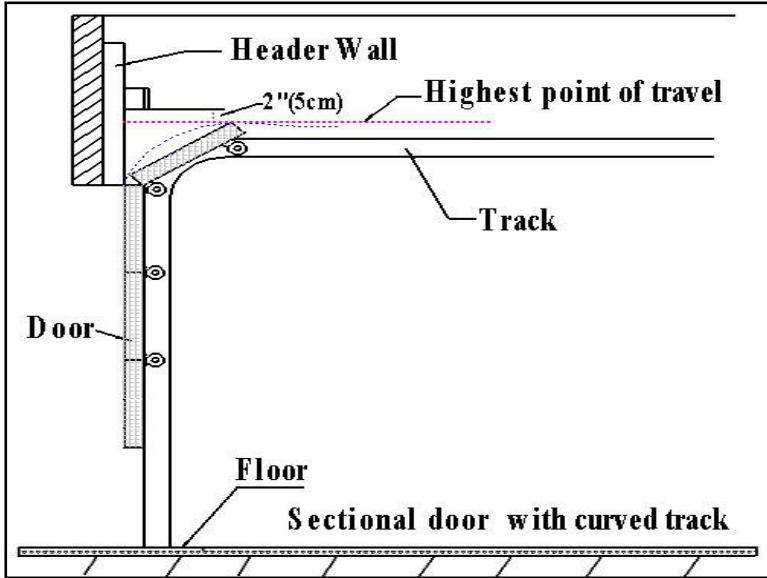

3. Install the Header Bracket You can attach the header bracket either to the wall above the garage door, or to the ceiling. Follow the instructions which will work best for your particular requirements. **Do not install the header bracket over drywall. If installing into masonry, use concrete anchors (not provided).**

HARDWARE: **B3** Lag Screw M8×50 (2)



Option A WALL INSTALLATION

3.1A Center the bracket on the vertical centerline with the bottom edge of the bracket on the horizontal line as shown (with the arrow pointing toward the ceiling).

3.2A Mark the holes. Drill 3/16" pilot holes and fasten the bracket securely to a structural support with the hardware provided.

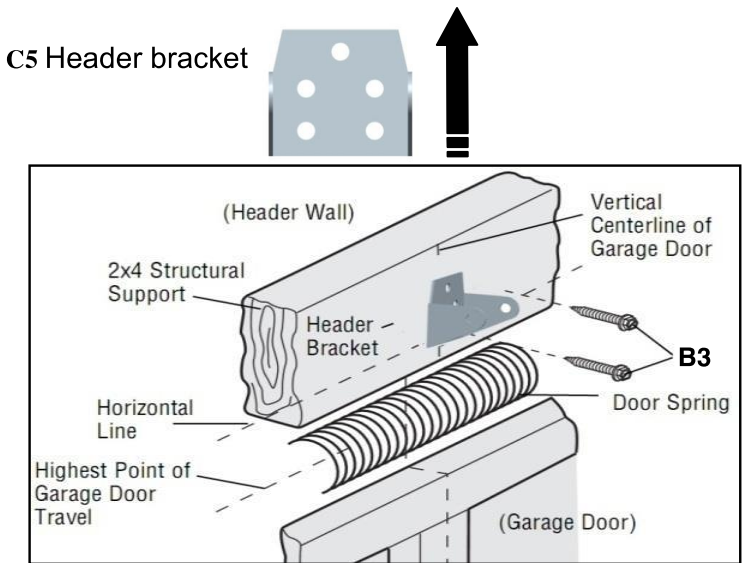

Option B CEILING INSTALLATION

3.1B Extend the vertical centerline onto the ceiling as shown.

3.2B Center the bracket on the vertical mark, no more than 6" (15 cm)

3.3B from the wall. Make sure the arrow is pointing away from the wall. The bracket can be mounted flush against the ceiling when clearance is minimal.

3.4B Mark the holes. Drill 3/16" pilot holes and fasten bracket securely to a structural support with the hardware provided.



C5 Header bracket

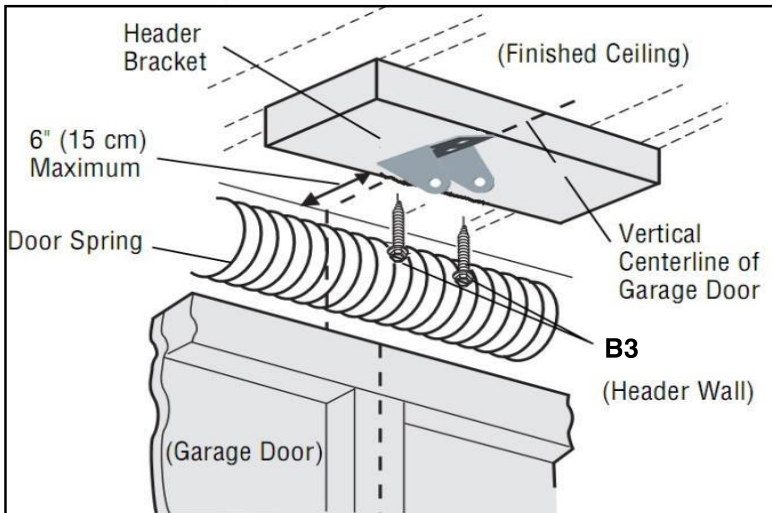

4. Connect the Rail to the Header Bracket

Align the rail to the header bracket, fasten with the bolts and nuts (H1) (H2) as shown below.

HARDWARE

B5 Cotter Pin $\Phi 2 \times 25(1)$

B6 Shouldered shaft, long $\Phi 8 \times 80(1)$

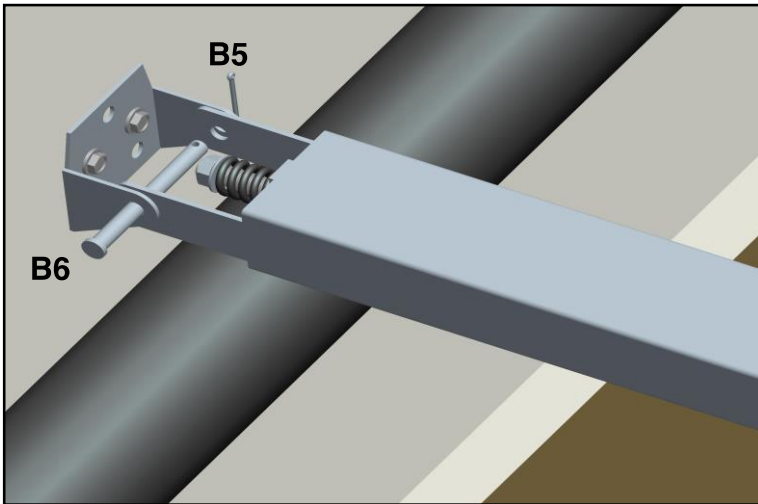
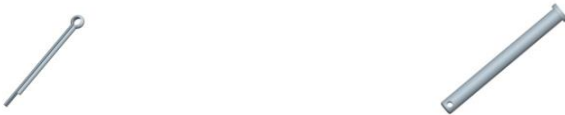

5. Position the garage door opener

CAUTION

To prevent damage to garage door, rest garage door opener rail on 2x4 placed on top section of door.

NOTE: A 2x4 is ideal for setting the distance between the rail and the door. If the ladder is not tall enough you will need help at this point.

- 4.1** Remove the packing material and lift the garage door opener onto a ladder.

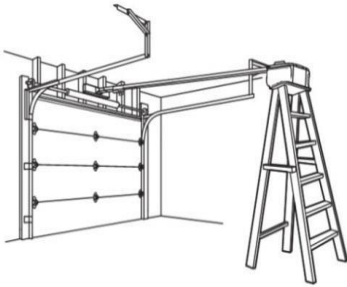

- 4.2** Fully open the door and place a 2x4 (laid flat) under the rail. For one-piece doors without tracks, lay the 2x4 on its side.

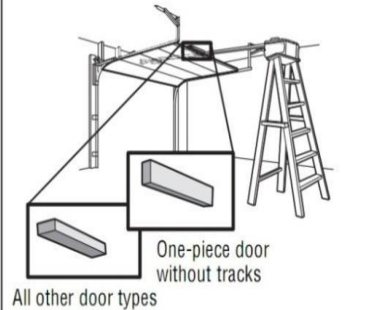

If the door hits the trolley when it is raised, pull the trolley release arm down to disconnect the chain connector kit and trolley. Slide the trolley toward the garage door opener. The trolley can remain disconnected until further instruction.

6. Hang the garage door opener



WARNING

To avoid possible **SERIOUS INJURY** from a falling garage door opener, fasten it **SECURELY** to structural supports of the garage. Concrete anchors **MUST** be used if installing **ANY** brackets into

HARDWARE

B1 Hex Bolt M8×20 (2)



B3 Lag Screw M8×50 (4)



B7 Hex Nut M8(2)

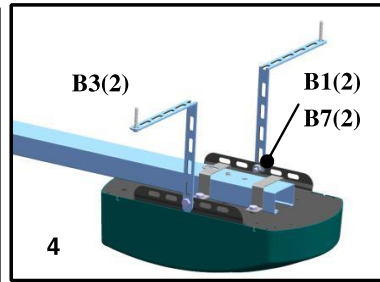
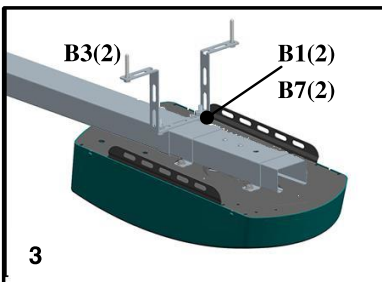
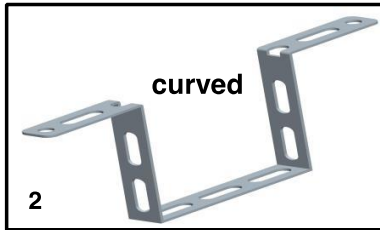
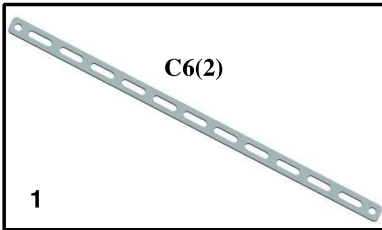

7、 Attach the Emergency Release Rope and Handle



WARNING

To prevent possible **SERIOUS INJURY** or **DEATH** from a falling garage door:

- If possible, use emergency release handle to disengage trolley **ONLY** when garage door is **CLOSED**. Weak or broken springs or unbalanced door could result in an open door falling rapidly and/or unexpectedly.
- **NEVER** use emergency release handle unless garage doorway is clear of persons and obstructions.
- **NEVER** use handle to pull door open or closed. If rope knot becomes untied, you could fall.

NOTE: If it is necessary to cut the emergency release rope, seal the cut end with a match or lighter to prevent unraveling. Ensure that the emergency release rope and handle are above the top of all vehicles to avoid entanglement.

7.1 Insert one end of the emergency release rope through the handle. Tie a knot at least 1 inch (2.5 cm) from the end of the emergency release rope.

7.2 Insert the other end of the emergency release rope through the hole in the trolley release arm. Make sure the handle is 6 feet (1.83 m) above the floor and secure with a knot.

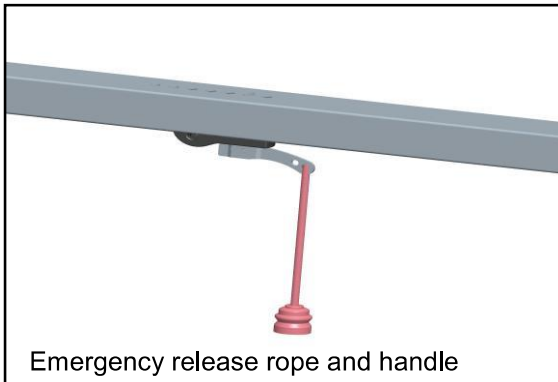

8. Install the door bracket

CAUTION

Fiberglass, aluminum or lightweight steel garage doors **WILL REQUIRE** reinforcement BEFORE installation of door bracket. Contact your door manufacturer for reinforcement kit.

Figure 1 shows one piece of angle iron as the horizontal brace. For the vertical brace, 2 pieces of angle iron are used to create a U-shaped support. The best solution is to check with your garage door manufacturer for an opener installation door reinforcement kit.

NOTE: Many door reinforcement kits provide for direct attachment of the clevis pin and door arm. In this case you will not need the door bracket; proceed to the next step.

HARDWARE

B8 Self-Threading Screw M6×20 (4)



Figure1:

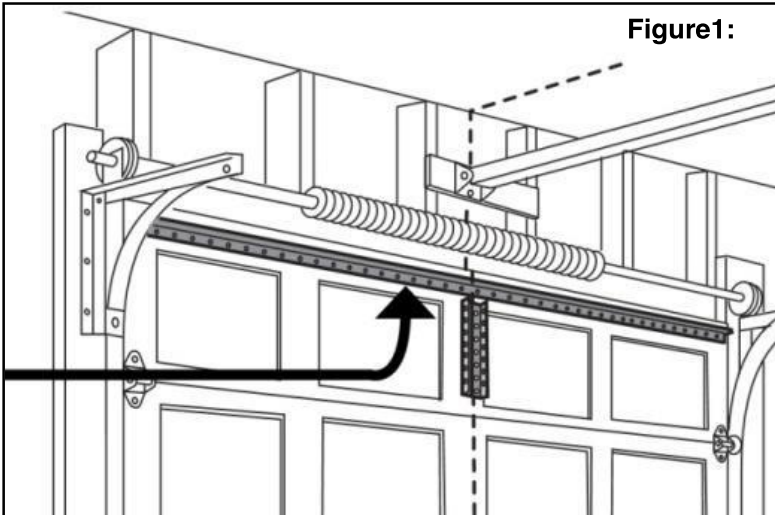

A horizontal and vertical reinforcement is needed for lightweight garage doors (fiberglass, aluminum, steel, doors with glass panel, etc.) (not provided). A horizontal reinforcement brace should be long enough to be secured to two or three vertical supports. A vertical reinforcement brace should cover the height of the top panel.
Option SECTIONAL DOORS

8.1 Center the door bracket on the previously marked vertical centerline used for the header bracket installation. Note correct UP placement, as stamped inside the bracket.

8.2 Position the top edge of the bracket 2"-4" (5-10 cm) below the top edge of the door, OR directly below any structural support across the top of the door.

8.3 Mark, drill holes and install as follows, depending on your door's construction:

Metal or light weight doors using a vertical angle iron brace between the door panel support and the door bracket:

· Drill 3/16" fastening holes. Secure the door bracket using the two self-threading screws (C2). (Figure 2)

· Alternately, use two 5/16" bolts, lock washers and nuts (not provided). (Figure 3)

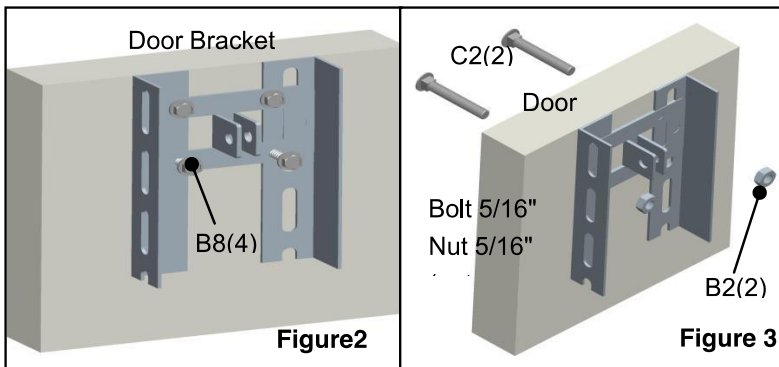

9. Connect the door arm to the trolley

B4 Shouldered shaft
Φ8×30 (2)

B7 Hex Nut
M8(2)

B1 Hex Bolt
M8×20(2)

B5 Cotter pin
Φ2×25(2)



HARDWARE

Option SECTIONAL DOORS NOTE: If the holes in the curved door arm and the straight door arm do not align, reverse the straight door arm, select two holes (as far apart as possible) and attach using bolts (H4) and nuts (H3).

9.1 Close the door. Disconnect the trolley by pulling the emergency release handle.

9.2 Attach the straight door arm to the outer trolley using the shouldered shaft (H2). Attach with the cotter (H5).

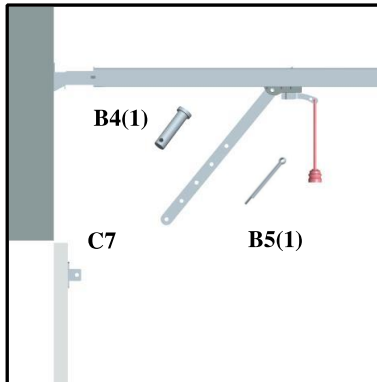
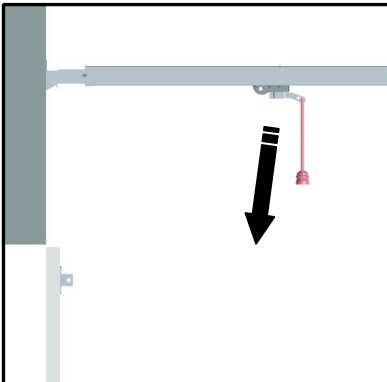

9.2 Attach the curved door arm to the door bracket using the shouldered shaft (H2). Attach with the cotter (H5).

9.4 Bring arm sections together. Find two pairs of holes that line up and join sections. Select holes as far apart as possible to increase door arm rigidity and attach using the bolts (H4), nuts (H3).

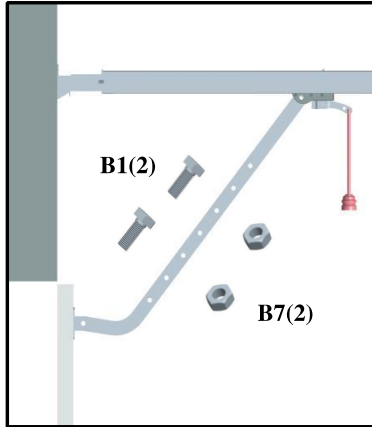
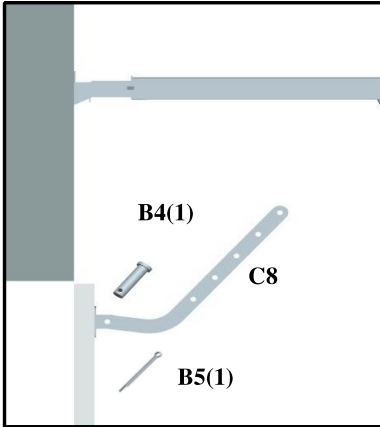

9.5 Pull the emergency release handle toward the chain/belt connector until they are connected, you will hear a click.

NOTE: If the straight door arm is hanging down too far, you may cut 6 inches (15 cm) from the solid end.

10. Install the Wall Control



WARNING

To prevent possible **SERIOUS INJURY** or **DEATH** from electrocution:

- Be sure power is **NOT** connected **BEFORE** installing door control.
- Connect **ONLY** to 24 VOLT low voltage wires.

To prevent possible **SERIOUS INJURY** or **DEATH** from a closing garage door:

- Install door control within sight of garage door, out of reach of children at a minimum height of 5 feet (1.5 m), and away from **ALL** moving parts of door.
- **NEVER** permit children to operate or play with door control push buttons or remote control transmitters.
- Activate door **ONLY** when it can be seen clearly, is properly adjusted, and there are no obstructions to door travel.
- **ALWAYS** keep garage door in sight until completely closed. **NEVER** permit anyone to cross path of closing garage door.

INTRODUCTION

Install the wall control within sight of the door at a minimum height of 5 feet (1.5 m) where small children cannot reach, and away from the moving parts of the door. Your product may look different than the illustrations.

HARDWARE

Drywall Anchors (2)

Screw M4×30 (2)



NOTE: For gang box installations it is not necessary to drill holes or install the drywall anchors. Use the existing holes in the gang box.

a

Disconnect power to the garage door opener. Remove the front cover of the wall control.

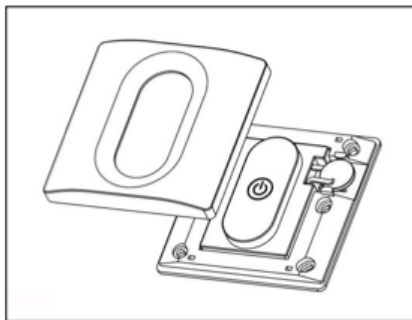
**b**

Position the wall control at a minimum height of 5 feet (1.5m), mark hole location on wall and drill 6mm pilot holes into the wall.

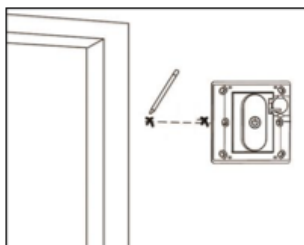
**c**

Insert and tighten screws to secure the back cover of the wall control to wall.

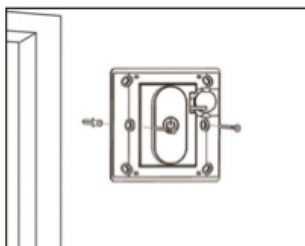

c

Snap the wall control onto the back cover.

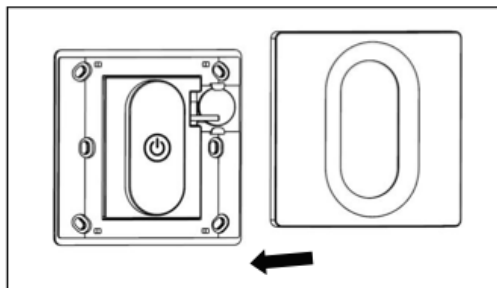

WALL CONTROL BATTERY REPLACEMENT

a

Unscrew and open the front cover gently.

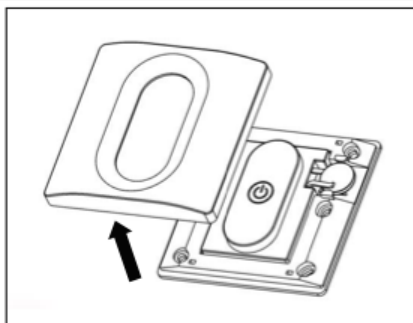
**b**

Replace the battery with a new one (3V CR2032 coin battery) and insert it correctly.

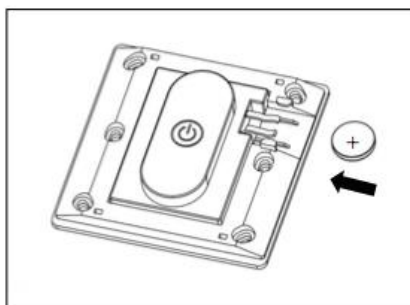

11. Wire the wall control to the garage door opener

11.1 Strip 7/16 inch (11 mm) of insulation from one end of the wire and separate the wires.

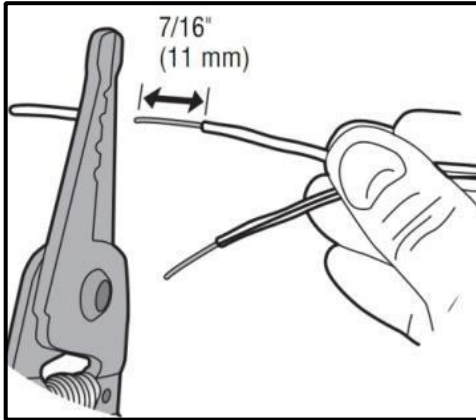

11.2 Connect the white wire to the GND terminal and the red/white wire to the PBSW terminal on garage door opener.

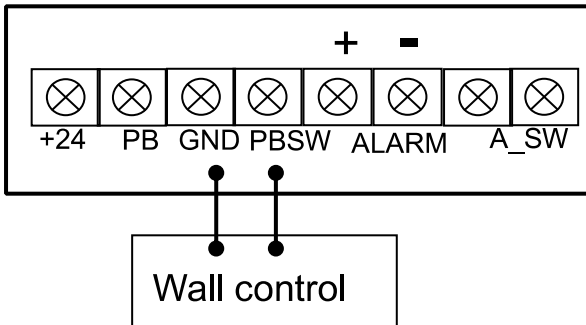

12. Attach the warning labels

12.1 Attach the entrapment warning label on the wall near the door control with tacks or staples.

12.2 Attach the manual release/safety reverse test label in a visible location on the inside of the garage door.

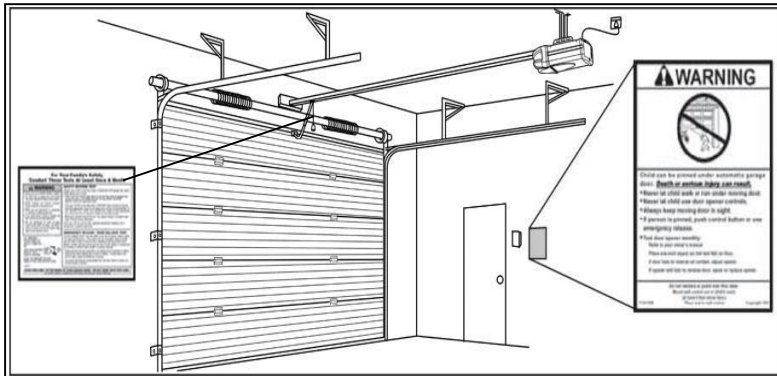

Install the Photo Eye Safety System

Introduction

WARNING

Be sure power is NOT connected to the garage door opener BEFORE installing the safety reversing sensor.

To prevent SERIOUS INJURY or DEATH from a closing garage door:

- Correctly connect and align the safety reversing sensor. This required safety device MUST NOT be disabled.
- Install the safety reversing sensor so beam is NO HIGHER than 6" (15 cm) above garage floor.

IMPORTANT INFORMATION ABOUT THE SAFETY REVERSING SENSOR The safety reversing sensor must be connected and aligned correctly before the garage door opener will move in the down direction.

The sending sensor (with a red LED) transmits an invisible light beam to the receiving sensor (with a green LED). If an obstruction breaks the light beam while the door is closing, the door will stop and reverse to the full open position, and the garage door opener lights will flash three minutes

NOTE: For energy efficiency the garage door opener will enter sleep mode when the door is fully closed. The sleep mode shuts the garage door opener down until activated. The sleep mode is sequenced with the garage door opener light bulb; as the light bulb turns off the sensor LEDs will turn off and whenever the garage door opener lights turn on the sensor LEDs will light. The garage door opener will not go into the sleep mode until the garage door opener has completed 5 cycles upon power up.

When installing the safety reversing sensors check the following:

- Sensors are installed inside the garage, one on either side of the door.
- Sensors are facing each other with the lenses aligned and the receiving sensor lens does not receive direct sunlight.
- Sensors are no more than 6 inches (15 cm) above the floor and the light beam is unobstructed.

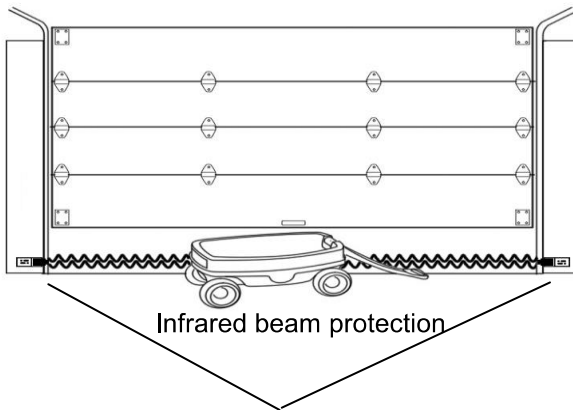
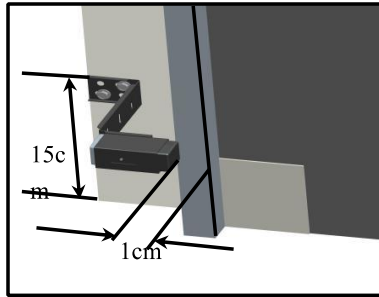

Photo eye Sensor 6"(15cm) max .above

Install the Photo Eye Safety System 1. Install the Safety Reversing Sensors

The safety reversing sensors can be attached to the wall, The sensors should be no more than 6 inches (15 cm) above the floor.

Cross recessed tapping screw
M6×35 (4)



Position the mounting bracket against the wall with the curved arms facing the door. Make sure there is enough clearance for the beam to be unobstructed. Attach the mounting bracket to the wall using lag screws.

Wire the Safety Reversing Sensors

Strip 7/16 inch (11 mm) of insulation from each set of wires. Separate the wires. Twist the white wires together. Twist the white/red wires together.

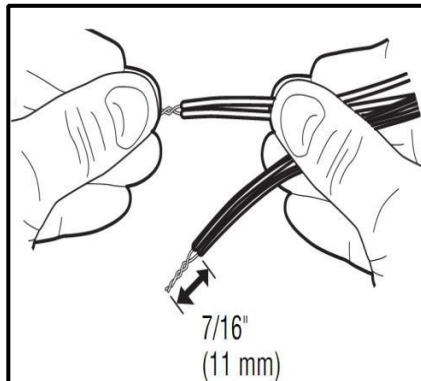

Insert the white wires into the GND terminal on the garage door opener. Insert the white/red wires into the PB terminal on the garage door opener.

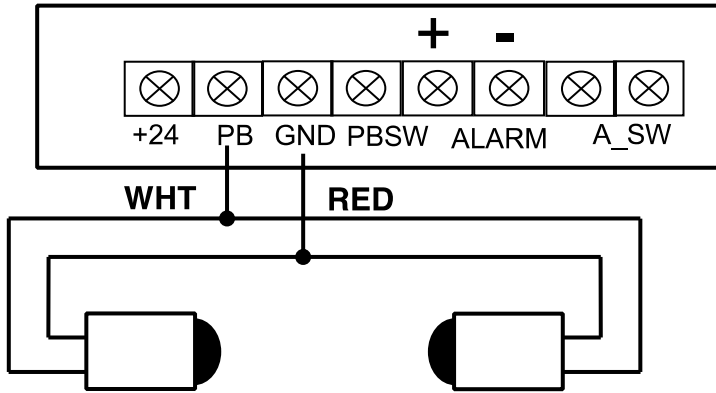

Ensure the Safety Reversing Sensors are aligned The door will not close if the sensors have not been installed and aligned correctly.

When the light beam is obstructed or misaligned while the door is closing, the door will reverse and the garage door opener lights will flash three minutes. If the door is already open, it will not close.

Check to make sure the LEDs in both sensors are glowing steadily .The LEDs in both sensors will glow steadily if they are aligned and wired correctly.

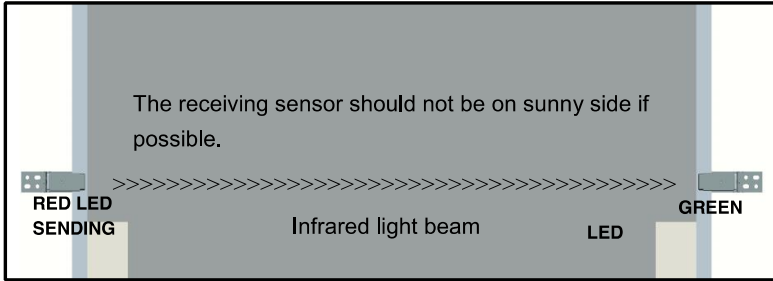

Power

Connect power



WARNING

To prevent possible **SERIOUS INJURY** or **DEATH** from electrocution or fire:

- Be sure power is **NOT** connected to the opener, and disconnect power to circuit **BEFORE** removing cover to establish permanent wiring connection.
- Garage door installation and wiring **MUST** be in compliance with **ALL** local electrical and building codes.
- **NEVER** change plug in any way to make it fit outlet.

Adjustments



WARNING

Without a properly installed safety reversal system, persons (particularly small children) could be **SERIOUSLY INJURED** or **KILLED** by a closing garage door.

- Incorrect adjustment of garage door travel limits will interfere with proper operation of safety reversal system.
- After **ANY** adjustments are made, the safety reversal system **MUST** be tested. Door **MUST** reverse on contact with 5 cm high.

CAUTION

To prevent damage to vehicles, be sure fully open door provides adequate clearance.

Programming and adjustment

a) Programming buttons

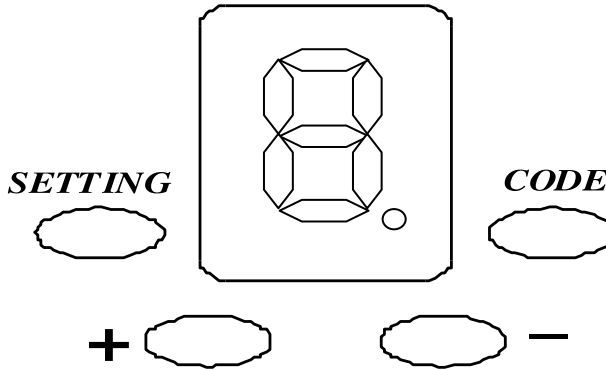

Note: “_” Down button, “+”Up button

b) Preparation:

Move the door to lock the trolley so that the opener can drive the door when adjustment.

c) Connect Power:

Puts through the power source, the LED display from “9” to “1”.

If the number direction displayed on LED is opposite, press button “SETTING”, the LED displayed would be inverted, then display again from “9” to “1”.

d) Program the travel

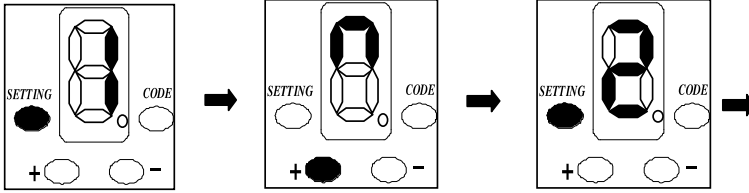

Press and hold the **SETTING** Button until the screen show "1".

Press and hold the "+" Button until the door in the desired UP position.

Once the door in the desired UP position press and release the **SETTING** Button. The screen will show "2".

NOTE: The **UP** and **DOWN** Buttons can be used to move the door up and down as needed.

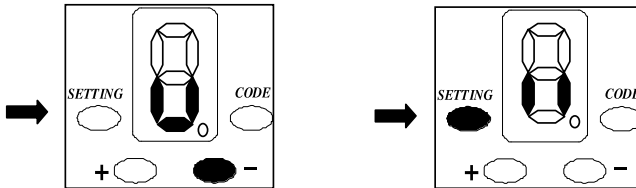

Press and hold the "-" Button until the door in the desired DOWN position.

Once the door is in the desired DOWN position, press and release the **SETTING** Button. The screen is flashing " | |".

NOTE: The **UP** and **DOWN** Buttons can be used to move the door up and down as needed.

e) Remote Control

PROGRAM A REMOTE USING THE CODE BUTTON

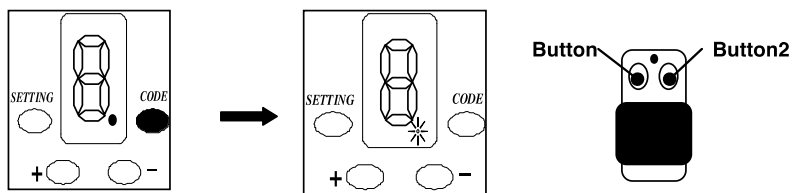

Press the **CODE** Button until the screen shows "●".

Within 10 seconds, press the button on the remote control, the "●" will turn off. Press the button again, the "●" will flash and turn off. Now, congratulation!

Note: Repeat up steps to code a maximum of 20 different remote controls.

To open or close the garage door, press and hold button. When the garage door move, release button. To stop garage door during travel, press and hold button until door stops, the release button.

To resume garage door travel after stopping, press button again. Door begins to move in the opposite direction.

f) To Erase the Memory

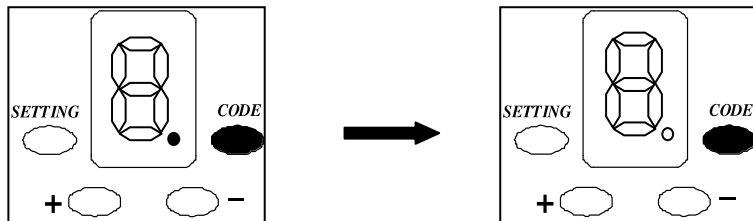

Press and hold the **CODE** button on garage door opener, the “●” will turn on. Release the **CODE** button when the “●” turns off. All remote control are now erased. Reprogram any accessory you wish to use.

g) The adjustment of reverse force

The "CLOSE" position force sensitivity

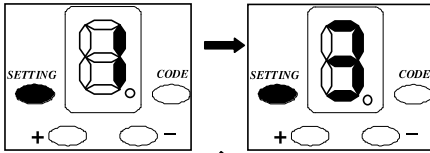

Press and hold the **SETTING** Button until the screen show the number from "1" to "3".

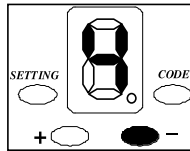
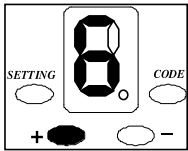

Use the **UP** Button to increase the levels, press the **DOWN** Button decrease the levels. The screen shows the number of the levels.

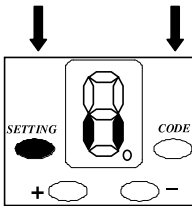

Press and release the **SETTING** Button and the screen is flashing " | | ". Adjustments are complete.

Level	1	2	3	4	5	6	7	8	9	
Low	—————→									High

Close door automatically

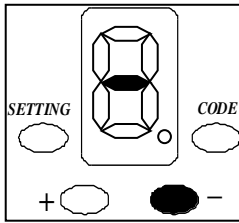

Press and hold the “+” Button until the screen show the “-”

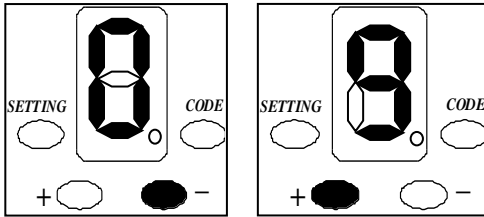

Press the **UP** or **Down** Button to select the closing time. The screen shows the number of the levels.

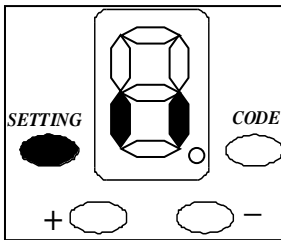

Press and release the **SETTING** Button and the screen is flashing “| |”. Adjustments are complete.

screen	1	2	3	4	5	6	7	8	9
minute	1	2	3	4	5	6	7	8	9

Note: The screen shows “0”, press button “SETTING” to confirm, at this time cancel automatically closing function.

Automatically door closing function is effective only under the complete open of the door, so if you want to cancel this function, you just need to close the door for a section.

h) Circuit board

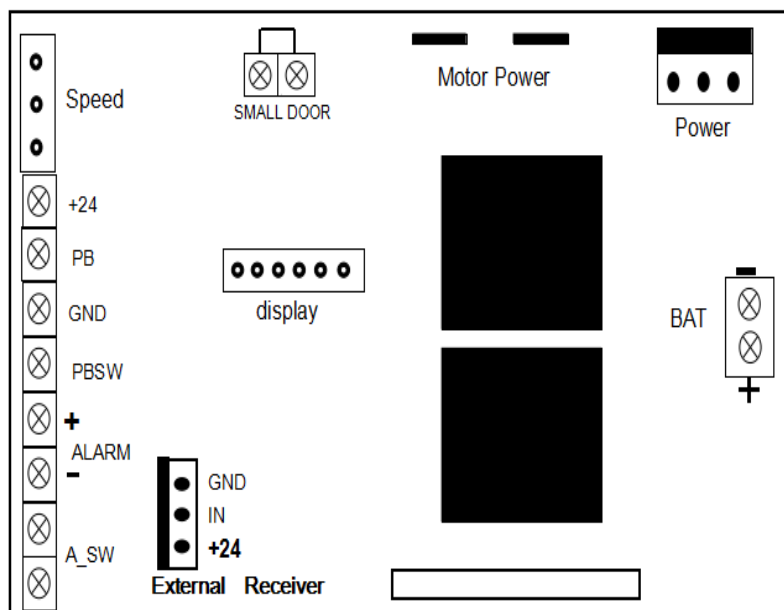

i) Use photoelectric switches

The user can simply push a button to set or cancel the photoelectric switch function.

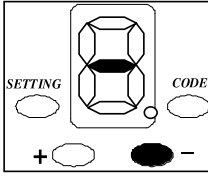

Press and hold the “—”Button until the screen show the “—”.

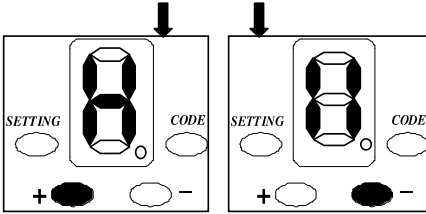

Press “+”, until the screen displays “H”, then, this function has been switched on. Press button “-”, until the screen shows “||”, this function has been switched off.

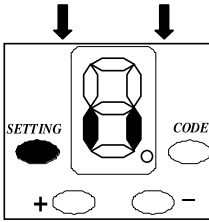

Press and release the **SETTING** Button and the screen is flashing “ || ”. Adjustments are complete.

Turn off light automatically

It has turned off light function so do not need to set. When the opener is running, the light is brighten automatically .If have no wall switch and press any button in **3** minutes, the light will be off automatically.

Power failure clutch lock

If your garage door is in the open position, when encountering power failure, you can pull the emergency release handle manually to disconnect the clutch with the chain connector, and then pull the door panel downward to the closing position manually; door panels will be blocked by the limit hole.

Backup battery

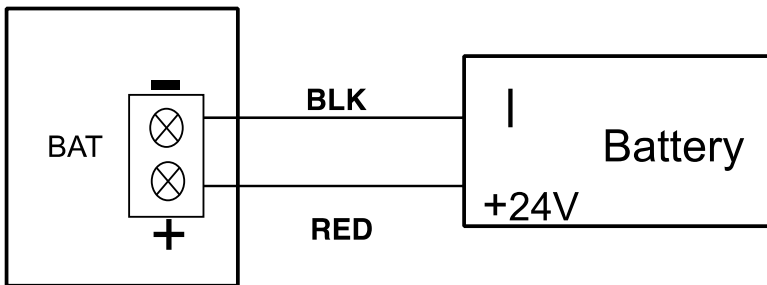

Door within a Door

SMALL DOOR

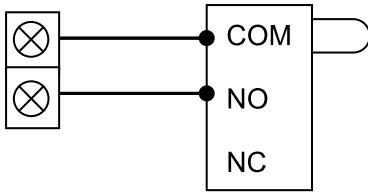

Maintenance and repair

Check the safety protection function of the opener at least one month regularly whether the closing state changed , it is sensitive for error recognition ,the door is keep balance and adjust in time, so as to keep the best state,. It is necessary for find a specialist to check and adjustment.

Technical parameter

- a. Rated voltage: POWER 1000 110V / 50Hz
- b. Motor: 24VDC
- c. Transmission frequency and range: 433MHz / open terrain 50m
- d. Max. Speed: 100mm/s
- e. Method of protection: Use only in dry rooms
- f. Standby power: <4W

Trouble shooting

Fault	Cause	Resolution
The door opener does not work.	<ul style="list-style-type: none"> •The plug is not inserted properly. 	<ul style="list-style-type: none"> •Plug the mains plug into the mains outlet.
Door is closing, stops and reverses.	<ul style="list-style-type: none"> • Obstruction, binding or sticking door 	<ul style="list-style-type: none"> • If your door is binding or sticking, contact a trained door systems technician. If your door is okay, reprogram the travel, refer to page 20.
The garage door opener will not close the door.	<ul style="list-style-type: none"> •The photoelectric switch function is opened. •Safety sensors are not installed, connected, or wires may be cut. • An obstruction breaks the light beam of the photoelectric switch. 	<ul style="list-style-type: none"> •Remove the obstacle. •Check the connection. • Cancel the photoelectric switch function. See page 23.
The remote control cannot actuate the garage door.	<ul style="list-style-type: none"> •The battery is out of power. • The remote control has not been registered at all. 	<ul style="list-style-type: none"> •Replace the battery •Program the remote control. See page 18.